

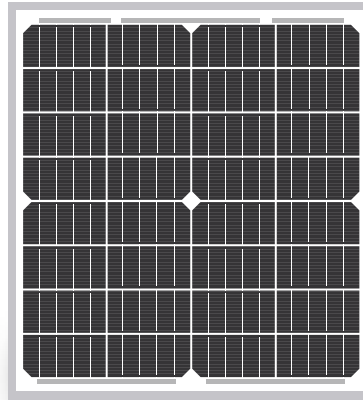

ST-20P-12

High Efficiency Monocrystalline PV Module

- Nominal 12V DC for standard output.
- Outstanding low-light performance.
- Heavy-duty anodized frames.
- High transparent low-iron, tempered glass.
- Designed to withstand high wind pressures, hail and heavy snow.
- Quality aesthetic appearance.



32 CELL
MONOCRYSTALLINE MODULE

20W
POWER OUTPUT

20.00%
MODULE EFFICIENCY

5%
POSITIVE TOLERANCE



High Efficiency

Module Efficiency improved through advanced cell technology and manufacturing capabilities



High PID Resistance

Advanced cell technology and qualified materials lead to high resistance to PID



Withstands Harsh Environment

High PID resistance, 5400 Pa positive load, 2400 Pa negative load, Salt mist (IEC 61701)

Performance Warranty

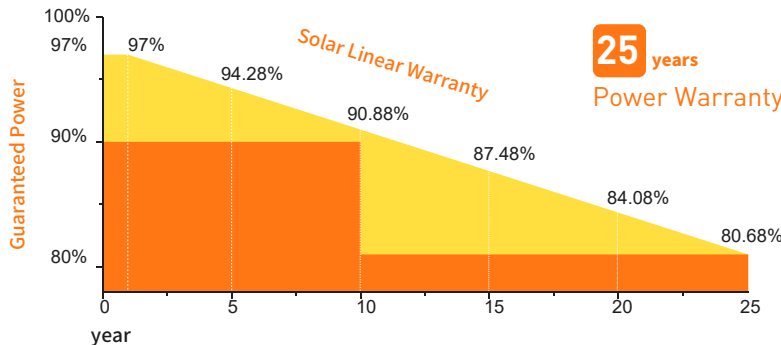

2 years
Product Warranty

25 years
Power Warranty

Wind Load/Snow Load:
2400pa/5400pa

Positive Power Tolerance:
0~+5W

Warranty Information:
2 Year Product Workmanship

Electrical Characteristics

Product code	020P3201A
Maximum power (Pmax)	20W
Voltage at Pmax (Vmp)	18.53V
Current at Pmax (Imp)	1.08A
Open-circuit voltage (Voc)	21.37V
Short-circuit current (Isc)	1.14A
Temperature coefficient of Voc	-(80±10)mV/°C
Temperature coefficient of Isc	(0.065±0.015)%/°C
Temperature coefficient of power	-(0.5±0.05)%/°C
NOCT (Air 20°C; Sun 0.8kW/m² wind 1m/s)	47±2°C
Operating temperature	-40°C to 85°C
Maximum system voltage	1000V DC
Power tolerance	± 5%

*STC: Irradiance 1000W/m², AM1.5 spectrum, module temperature 25°C
 *NOCT: Nominal operating cell temperature (the data is only for reference)

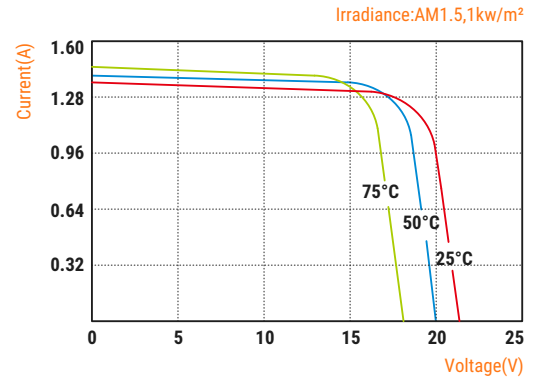

I-V Curves (STC)

Specifications

Cells	Monocrystalline silicon solar cell
No. of cells and connections	32(4X8)
Module dimension	15.35in.x14.17in.x1.18in.[390mmx360mmx30mm]
Weight	4.00lbs[1.81kg]
Packing information(Carton)	17.32in.x16.14in.x3.15in.[440mmx410mmx80mm]/(1pc/ctn)

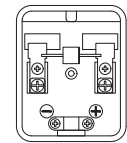
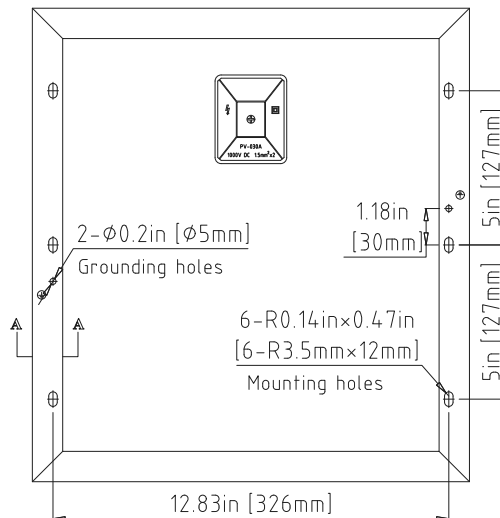
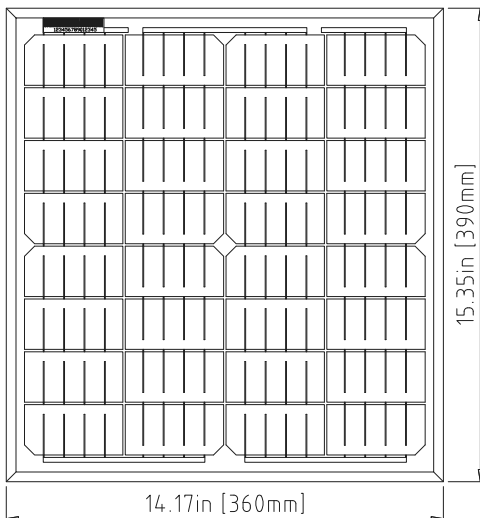

Junction Box
Top View (Lid Open)

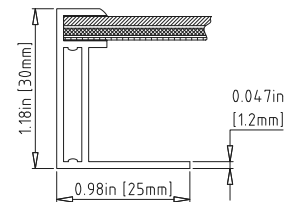

Section A-A